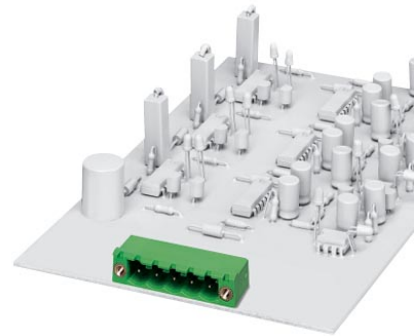

MSTB 2,5/ 5-GF-5,08

Order No.: 1776537

<http://eshop.phoenixcontact.de/phoenix/treeViewClick.do?UID=1776537>

Headers with threaded flange, nominal current: 12 A, rated voltage:
250 V, pitch: 5,08 mm, no. of positions: 5, mounting: Soldering

Commercial data

EAN	4017918038700
Pack	50 Pcs.
Customs tariff	85366990
Weight/Piece	0.003816 KG
Catalog page information	Page 219 (CC-2007)

Product notes

WEEE/RoHS-compliant since:
01/01/2003



[http://
www.download.phoenixcontact.com](http://www.download.phoenixcontact.com)
Please note that the data given
here has been taken from the
online catalog. For comprehensive
information and data, please refer
to the user documentation. The
General Terms and Conditions of
Use apply to Internet downloads.

Technical data**Dimensions / positions**

Pitch	5.08 mm
Dimension a	20.32 mm
Number of positions	5
Pin dimensions	1 x 1 mm
Hole diameter	1.4 mm

Technical data

Insulating material group	IIIa
Rated surge voltage (III/3)	4 kV
Rated surge voltage (III/2)	4 kV
Rated surge voltage (II/2)	4 kV
Rated voltage (III/2)	320 V
Rated voltage (II/2)	400 V
Connection in acc. with standard	EN-VDE
Nominal current I_N	12 A
Nominal voltage U_N	250 V
Maximum load current	12 A
Insulating material	PBT
Inflammability class acc. to UL 94	V0

Certificates / Approvals

Approval logo



CSA

Nominal voltage U_N	300 V
Nominal current I_N	10 A

CUL

Nominal voltage U_N	300 V
Nominal current I_N	10 A

UL

Nominal voltage U_N	300 V
Nominal current I_N	10 A
Certification	CB, CSA, CUL, GL, GOST, RS, UL, VDE-PZI

Accessories

Item	Designation	Description
Assembly		
1755477	MSTB-BL	Keying cap, for forming sections, plugs onto header pin, green insulating material
Marking		
1051993	B-STIFT	Marker pen, for manual labeling of unprinted Zack strips, smear-proof and waterproof, line thickness 0.5 mm
0804293	SK 5,08/3,8:FORTL.ZAHLEN	Marker card, printed horizontally, self-adhesive, 12 identical decades marked 1-10, 11-20 etc. up to 91-(99)100, sufficient for 120 terminal blocks
0805085	SK 5,08/3,8:SO	Marker card, special printing, self-adhesive, labeled acc. to customer requirements, 12 identical marker strips per card, max. 25-position labeling per strip, color: white
0805412	SK 5,08/3,8:UNBEDRUCKT	Marker cards, unprinted, with pitch divisions, self-adhesive, 10-section marker strips, 12 strips per card, can be labeled with the M-PEN
Plug/Adapter		
1734401	CR-MSTB	Coding section, inserted into the recess in the header or the inverted plug, red insulating material

Additional products

Item	Designation	Description
General		
1873236	FKC 2,5/ 5-STF-5,08	Plug with screw flange, nominal current: 12 A, rated voltage: 250 V, pitch: 5.08 mm, no. of positions: 5, type of connection: Spring-cage connection
1902330	FKCT 2,5/ 5-STF-5,08	Plug component, nominal current: 12 A, rated voltage: 250 V, pitch: 5.08 mm, no. of positions: 5, type of connection: Spring-cage connection
1874138	FKCVR 2,5/ 5-STF-5,08	Plug component, nominal current: 12 A, rated voltage: 250 V, pitch: 5.08 mm, no. of positions: 5, type of connection: Spring-cage connection
1873838	FKCVW 2,5/ 5-STF-5,08	Plug component, nominal current: 12 A, rated voltage: 250 V, pitch: 5.08 mm, no. of positions: 5, type of connection: Spring-cage connection
1777837	FRONT-MSTB 2,5/ 5-STF-5,08	Plug with screw flange, nominal current: 12 A, rated voltage: 250 V, pitch: 5,08 mm, no. of positions: 5, type of connection: Screw connection

1778014	MSTB 2,5/ 5-STF-5,08	Plug with T-shape and screw flange, nominal current: 12 A, rated voltage: 250 V, pitch: 5.08 mm, no. of positions: 5, type of connection: screw connection
1809763	MSTBC 2,5/ 5-STZF-5,08	Plug component, nominal current: 12 A, rated voltage: 320 V, pitch: 5.08 mm, no. of positions: 5, type of connection: Crimp connection
1805330	MSTBT 2,5/ 5-STF-5,08	Plug with T-shape and screw flange, nominal current: 12 A, rated voltage: 250 V, pitch: 5.08 mm, no. of positions: 5, type of connection: screw connection
1849118	MSTBVK 2,5/ 5-STF-5,08	Plug component, nominal current: 12 A, rated voltage: 320 V, pitch: 5.08 mm, no. of positions: 5, type of connection: Screw connection
1835122	MVSTBR 2,5/ 5-STF-5,08	Plug with screw flange, nominal current: 12 A, rated voltage: 250 V, pitch: 5,08 mm, no. of positions: 5, type of connection: Screw connection
1834932	MVSTBW 2,5/ 5-STF-5,08	Plug with screw flange, nominal current: 12 A, rated voltage: 250 V, pitch: 5,08 mm, no. of positions: 5, type of connection: Screw connection
1918120	QC 0,75/ 5-STF-5,08	Plug component, 5.08 mm pitch, color: green, no. of positions 5, dimension a 20.32 mm
1883381	QC 1/ 5-STF-5,08	Plug, nominal current: 10 A, rated voltage: 500 V, pitch: 5.08 mm, number of positions: 5, connection method: Insulation displacement connection QUICKON
1853133	TMSTBP 2,5/ 5-STF-5,08	Plug with screw flange, nominal current: 12 A, rated voltage: 250 V, pitch: 5,08 mm, no. of positions: 5, type of connection: Screw connection
1859205	UMSTBVK 2,5/ 5-STF-5,08	Plug component, nominal current: 12 A, rated voltage: 320 V, pitch: 5.08 mm, no. of positions: 5, type of connection: Screw connection

Drawings

Drilling diagram

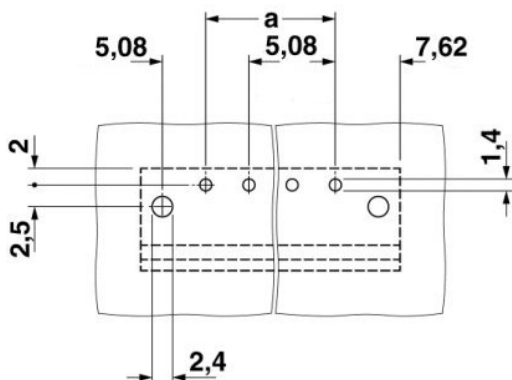

Diagram

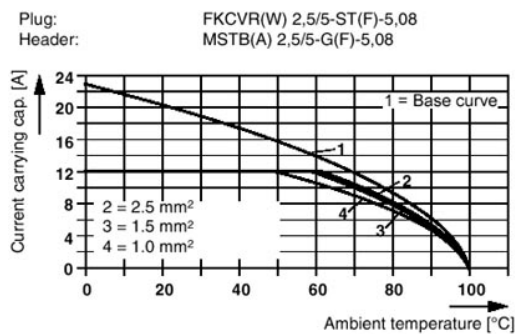
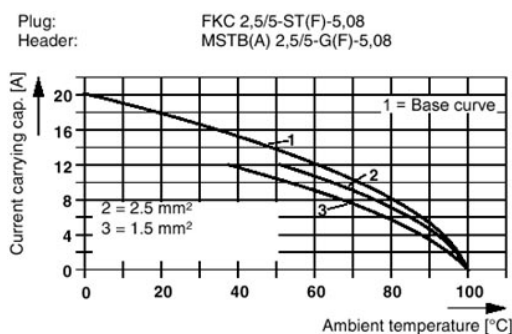
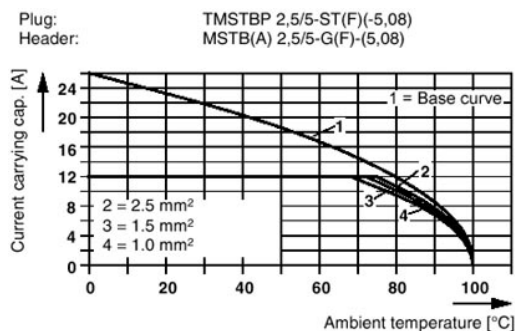
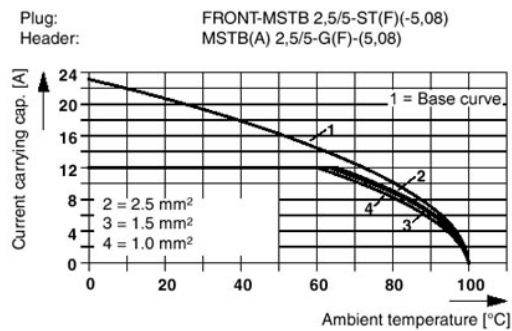
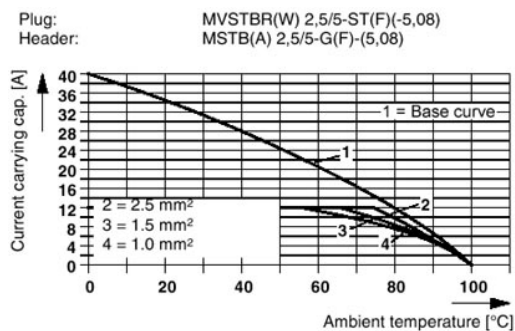
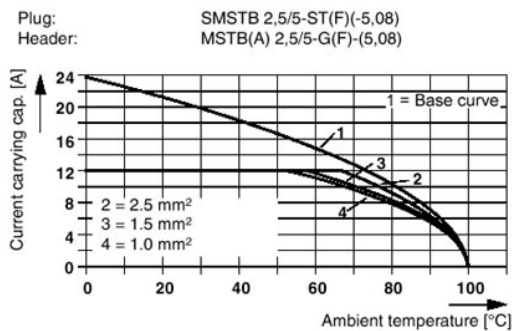
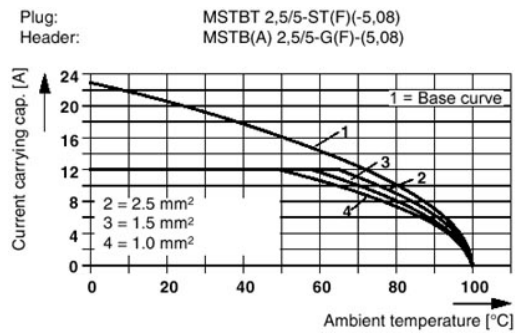
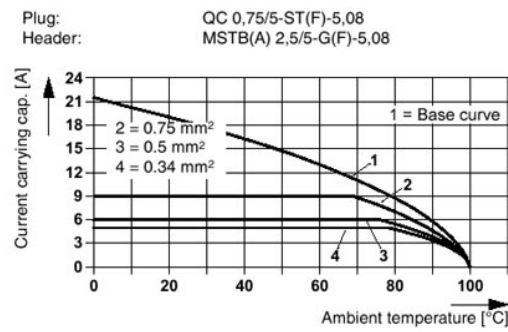

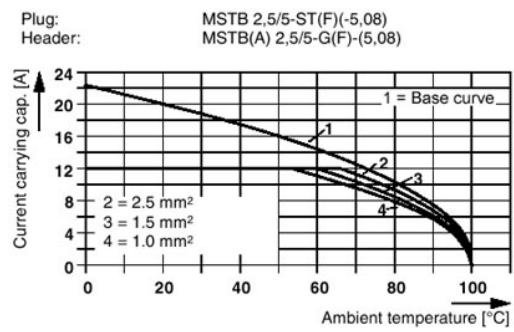
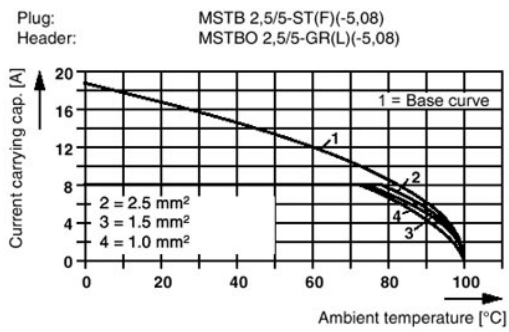

Dimensioned drawing

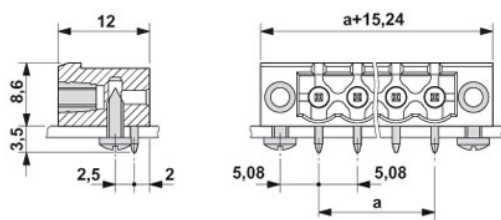

Address

PHOENIX CONTACT GmbH & Co. KG
Flachsmarktstr. 8
32825 Blomberg, Germany
Phone +49 5235 3 00
Fax +49 5235 3 41200
<http://www.phoenixcontact.com>



© 2008 Phoenix Contact
Technical modifications reserved;